

BHR

COMMUNITY

BLOK DIAGRAM

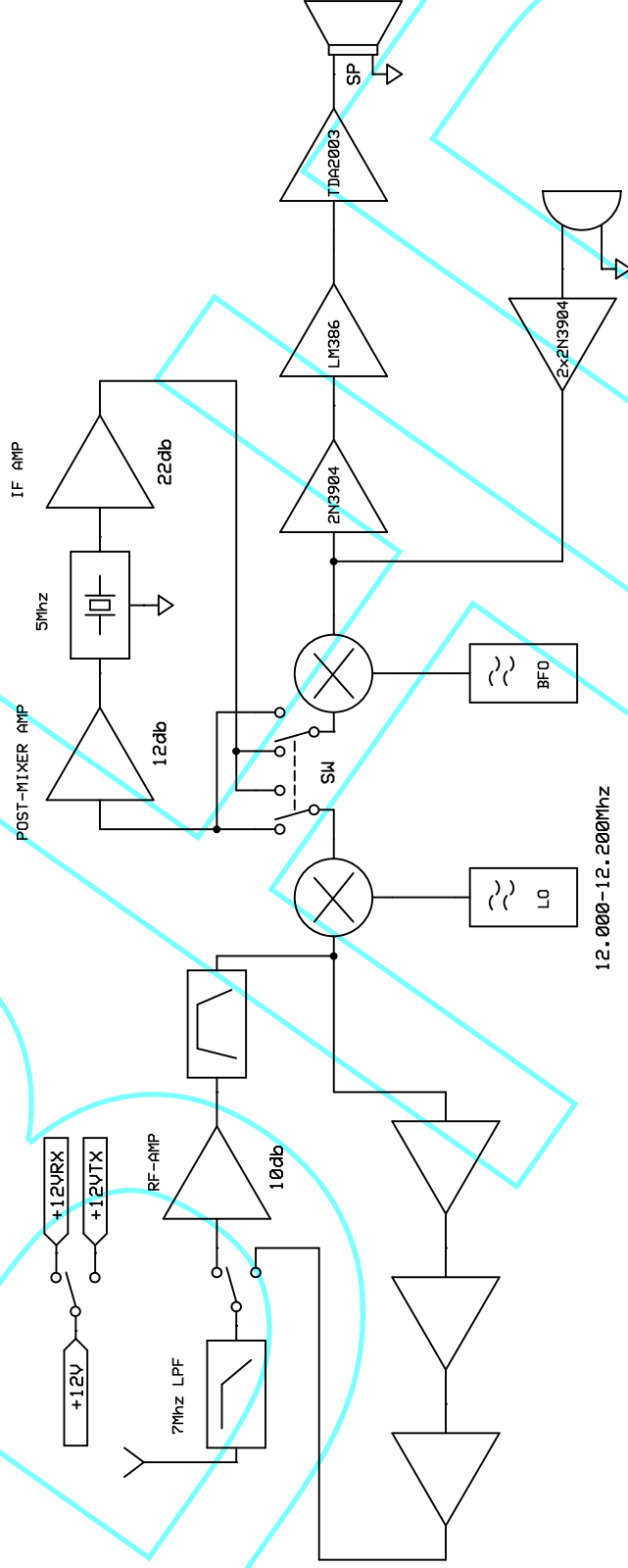

RADIO BEBEK

40M QRP SSB TRANSCEIVER

Designed by : YD1JJJ, YC1COZ, YC1EMK,
YC1HBP, YF00, YC2MAP, YD1ART, YC0EX0

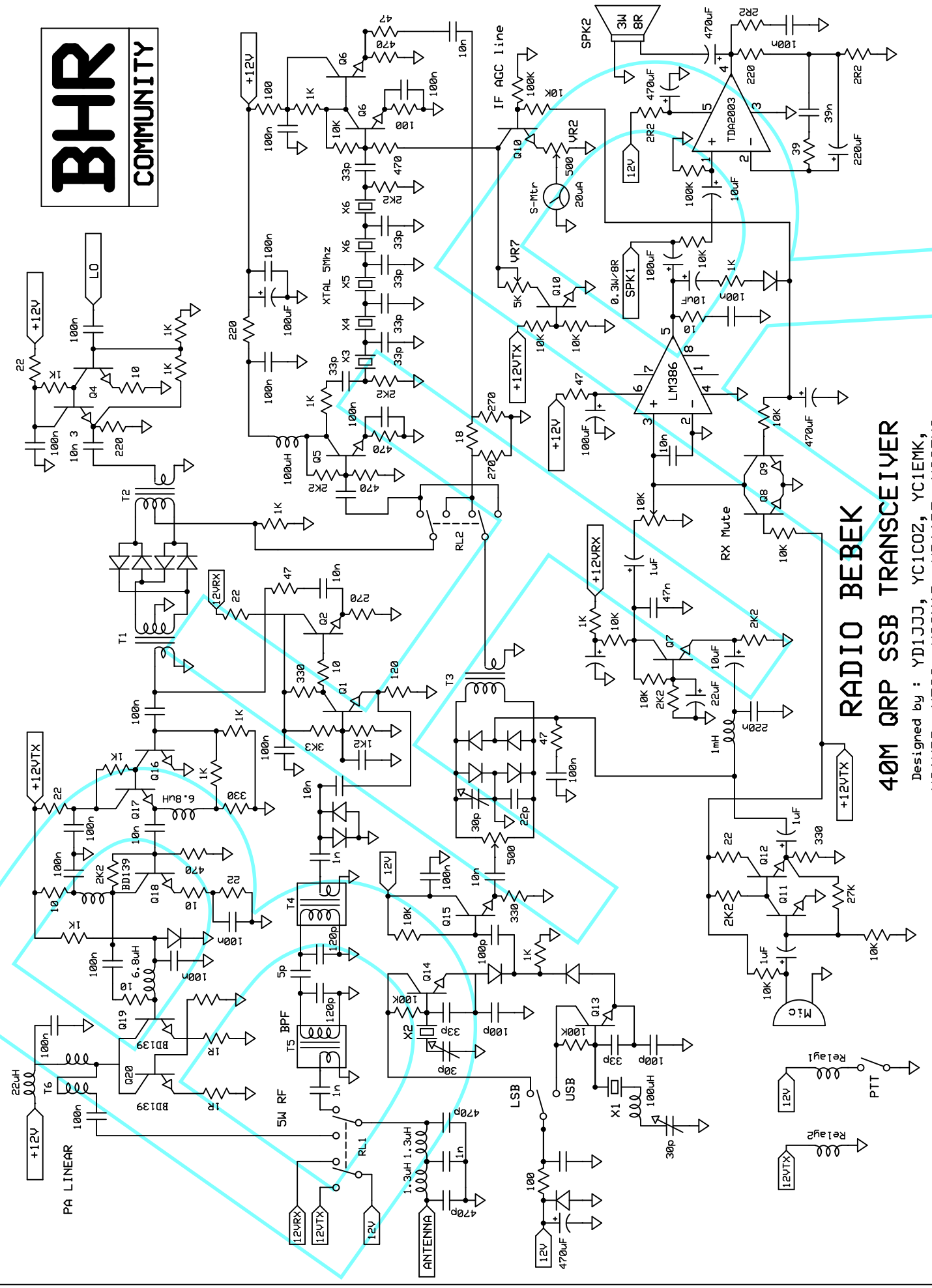

RADIO BEBEK 40M QRP SSB TRANSCEIVER

Designed by : YD1JJJ, YC1COZ, YC1EMK, YC1HBP, YF00, YC2MAP, YD1ART, YC0EX0

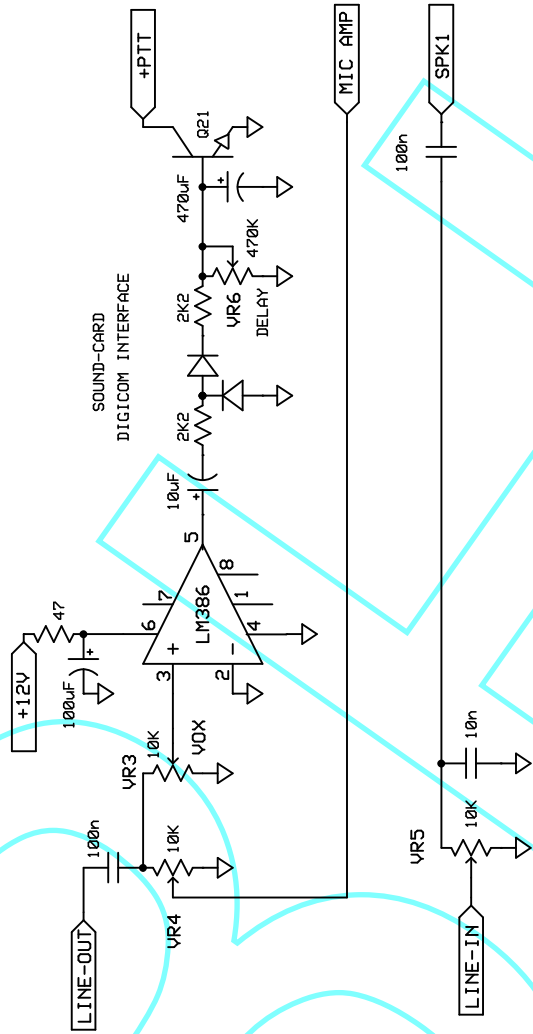

KETERANGAN :

- T1, T2 = Trifilar 3 lilitan pada FT-37-43
- T3 = bifilar 4 lilitan pada FT-37-43
- T4, T5 = IFT10.7 Mhz, capacitor tidak dilepas
- Q18, Q19, Q20 = BD139
- Transistor lainnya 2N3904
- Semua diode 1N4148
- xtal menggunakan 5Mhz atau 6 Mhz

RADIO BEBEK
40M QRP SSB TRANSCEIVER

Designed by : YD1JJJ, YC1COZ, YC1EMK,
YC1HBP, YF00, YC2MAP, YD1ART, YC0EXO

Daftar Komponen RADIO BEBEK

	Jenis	Jumlah
IC		1
	LM386	1
	TDA2003	
Transistor		20
	2N3904	3
	BD139	
Relay	DPDT 12V	2
Inductor		2
	T37-2	6
	T37-45	1
	100uH	1
	1mH	3
	6.8uH	
Lain-lain		
	Electret Mic	1
	Speaker 10W	1
	Soket stereo	2
		44
	Jumlah komponen	266

Kapasitor	Nilai	Jumlah
	470uF	6
	220uF	1
	100uF	6
	22uF	1
	10uF	5
	1uF	1
	100n	37
	39n	1
	10n	22
	1n	2
	470p	2
	120p	2
	100p	5
	33p	9
Trimmer	22p	1
	10p	1
	30p	1
Diode		
	1N4002	3
	1N4148	18
		124

Resistor	Nilai	Jumlah
	1R	2
	2R2	3
	10	5
	22	7
	47	4
	100	2
	220	3
	270	3
	330	3
	470	3
	1K	15
	2K2	9
	4K7	4
	10K	13
	22K	2
	27K	3
	18	1
	47	5
	100K	4
	39	1
Trimpot	5K	1
	10K	3
	500K	1
	500R	1
		98

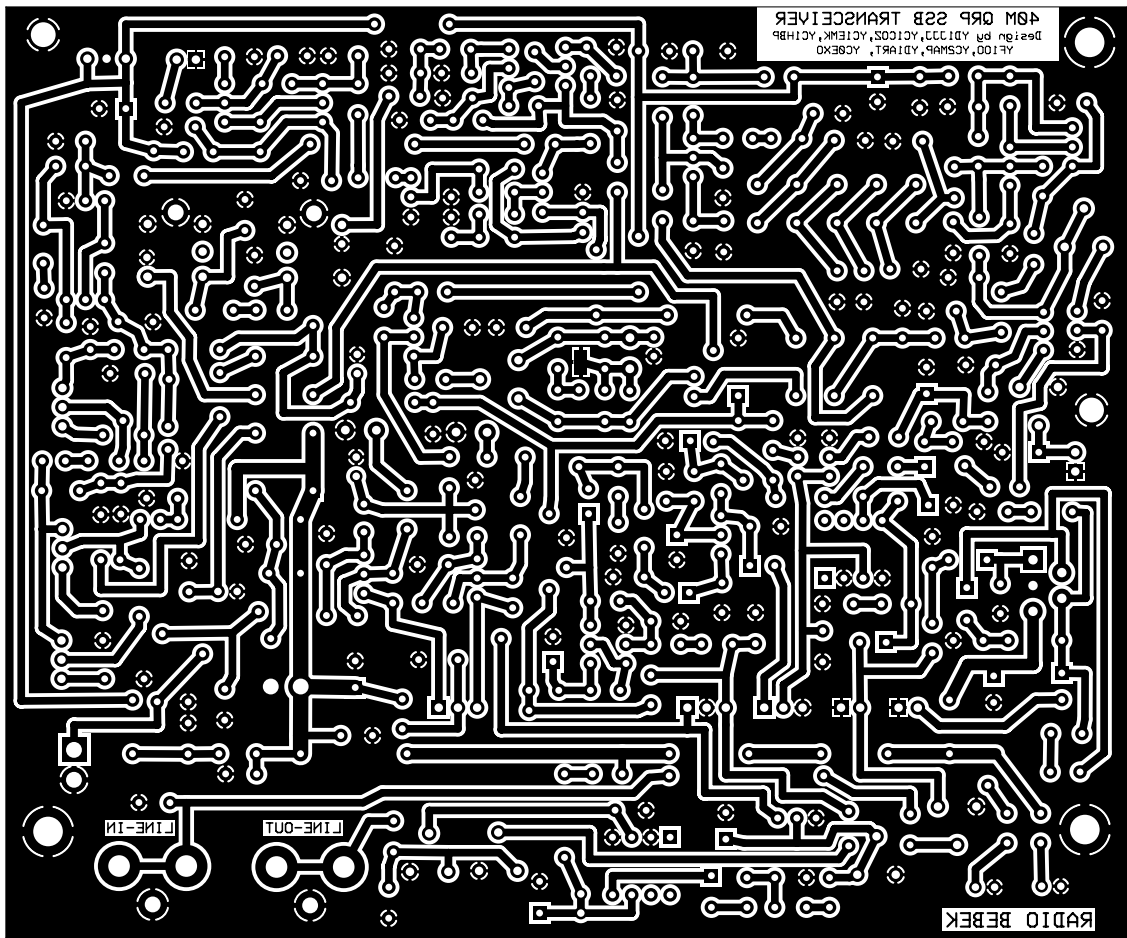

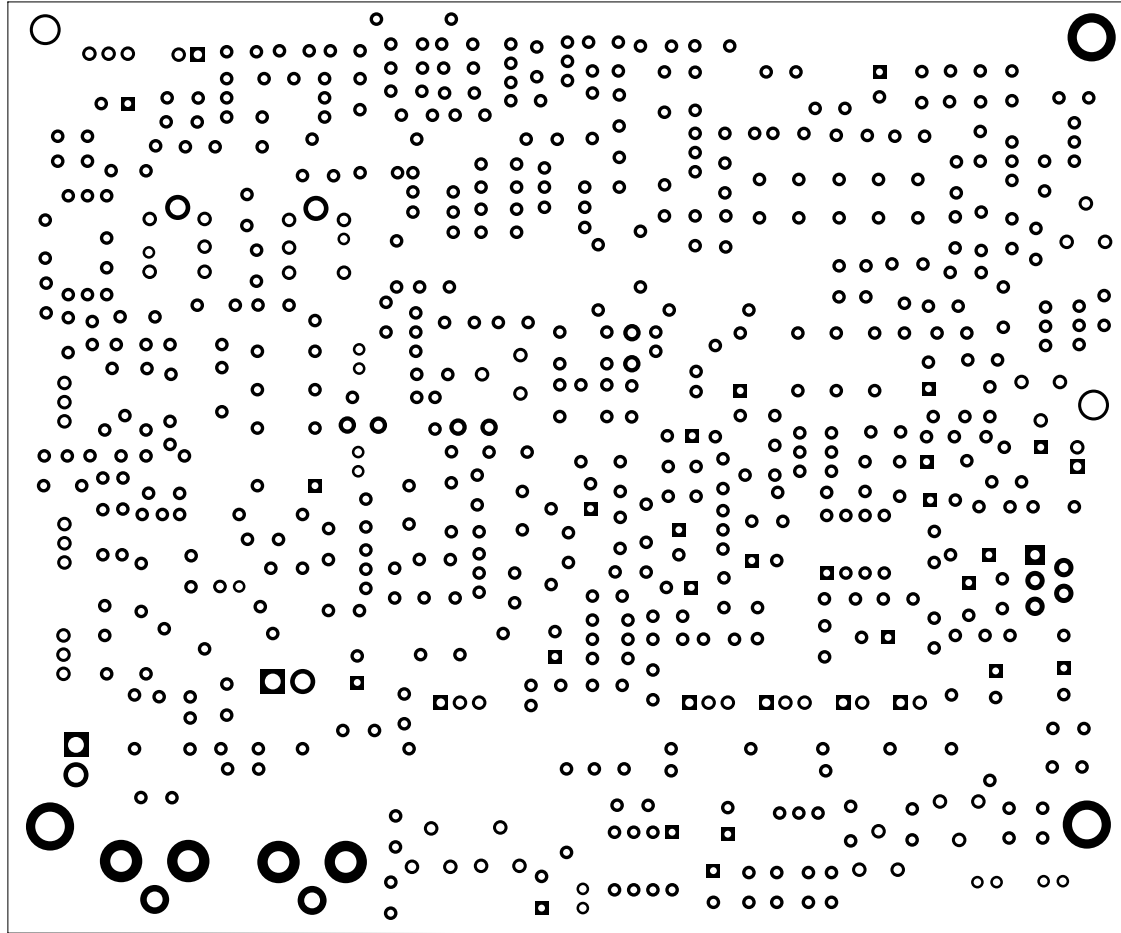

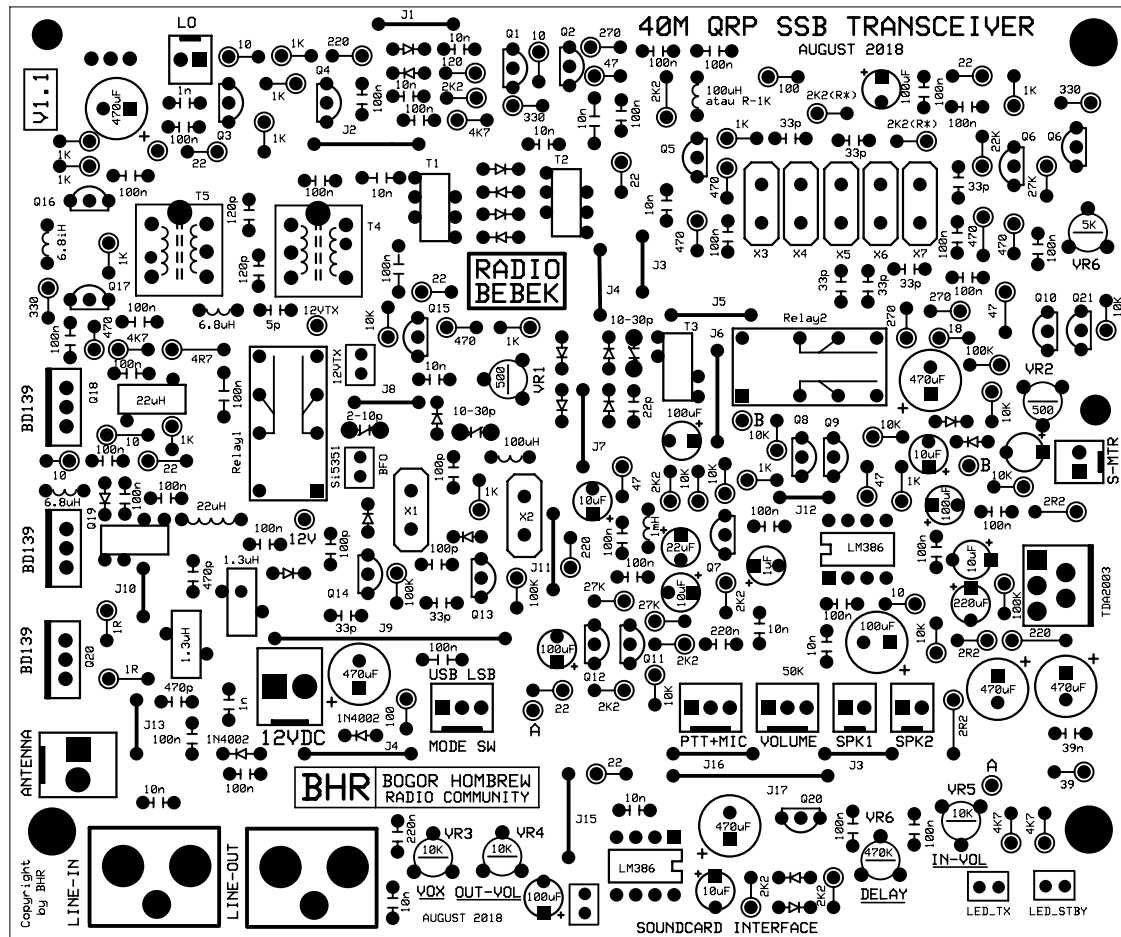

14.83 cm x 12.30 cm

40M QRP SSB TRANSCEIVER

AUGUST 2018

RADIO BEBEK

BHR BOGOR HOMBREW RADIO COMMUNITY

Copyright by BHR

AUGUST 2018

SOUNDCARD INTERFACE

LO

BFO

Mode Switch

To Sound Card

S-Meter

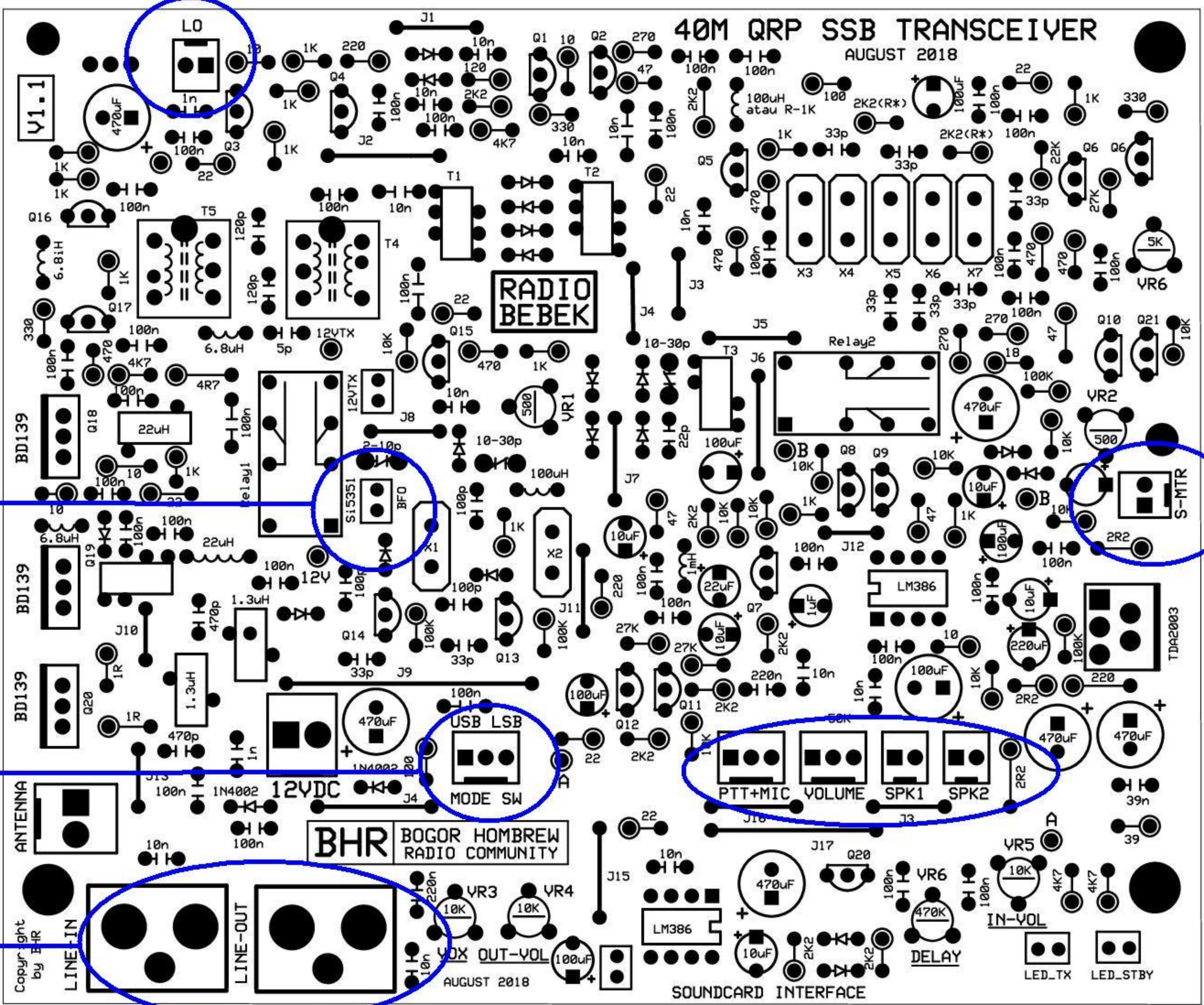

40M QRP VSSB TRANSCEIVER

Design by Y01JLJ, YC1C0Z, YC1EMK, YC1HBP, YF100, YCSMP, YCSMP

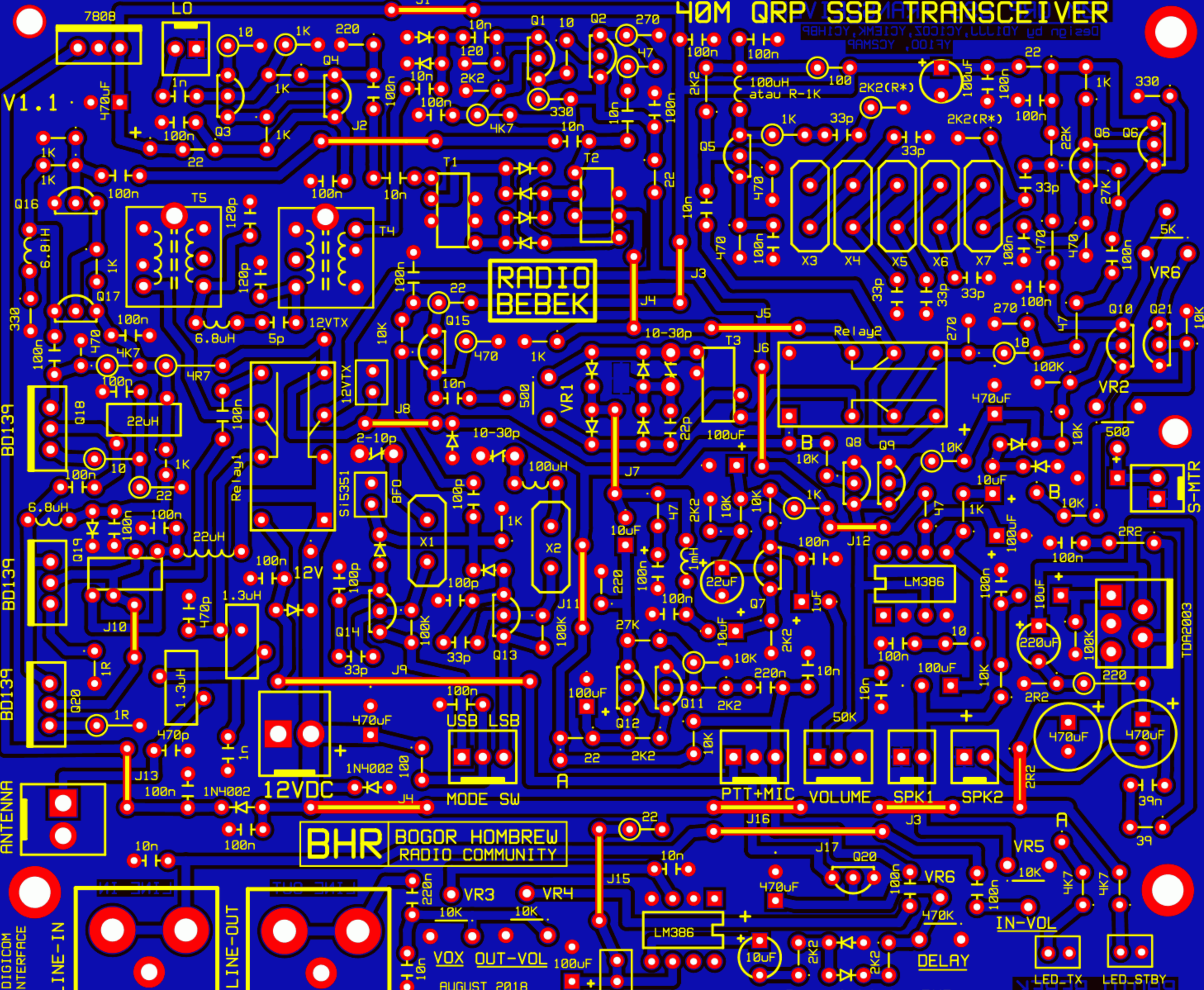

V1.1

RADIO BEBEK

BHR BOGOR HOMBREW RADIO COMMUNITY

DIGICOM INTERFACE

LINE-IN

LINE-OUT

AUGUST 2018

Copyright by BHR

RADIO BEBEK

LED-TX LED-STBY

40M QRP SSB TRANSCEIVER

V1.1

RADIO BEBEK

BHR BOGOR HOMBREW RADIO COMMUNITY

AUGUST 2018

Copyright by BHR

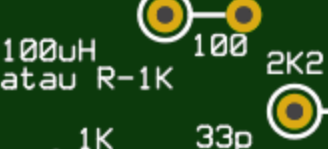
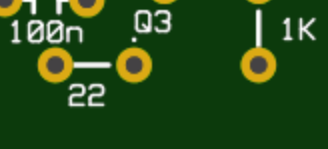
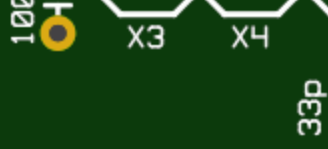
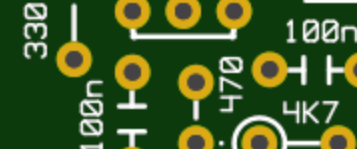
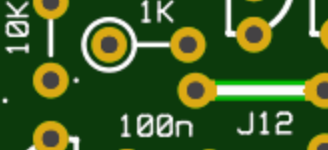
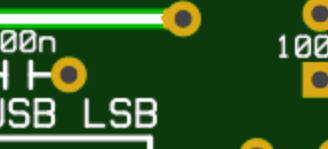
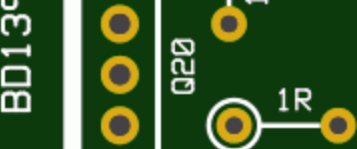
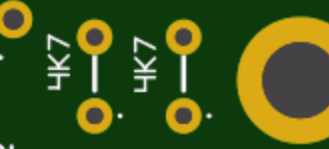
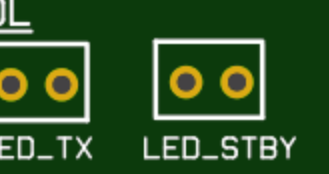
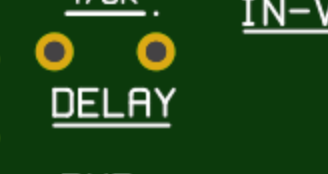
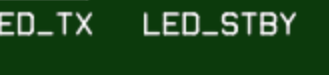
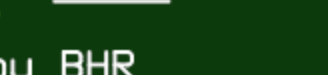
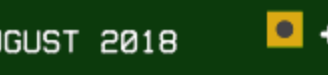
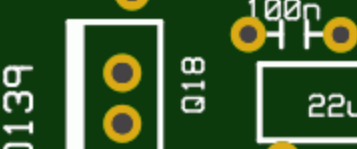
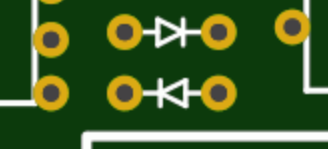
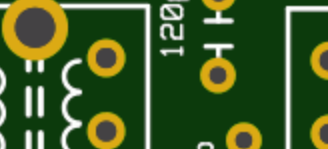
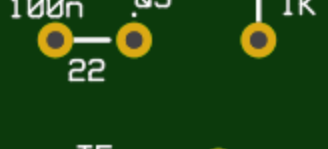
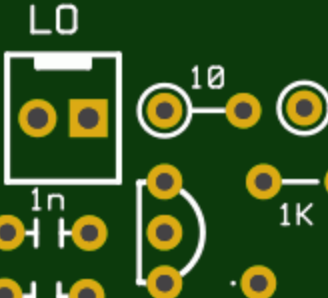
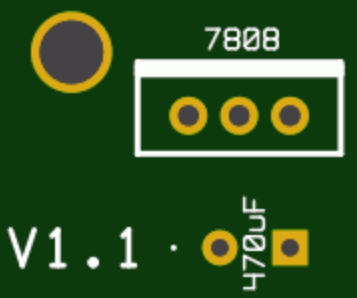
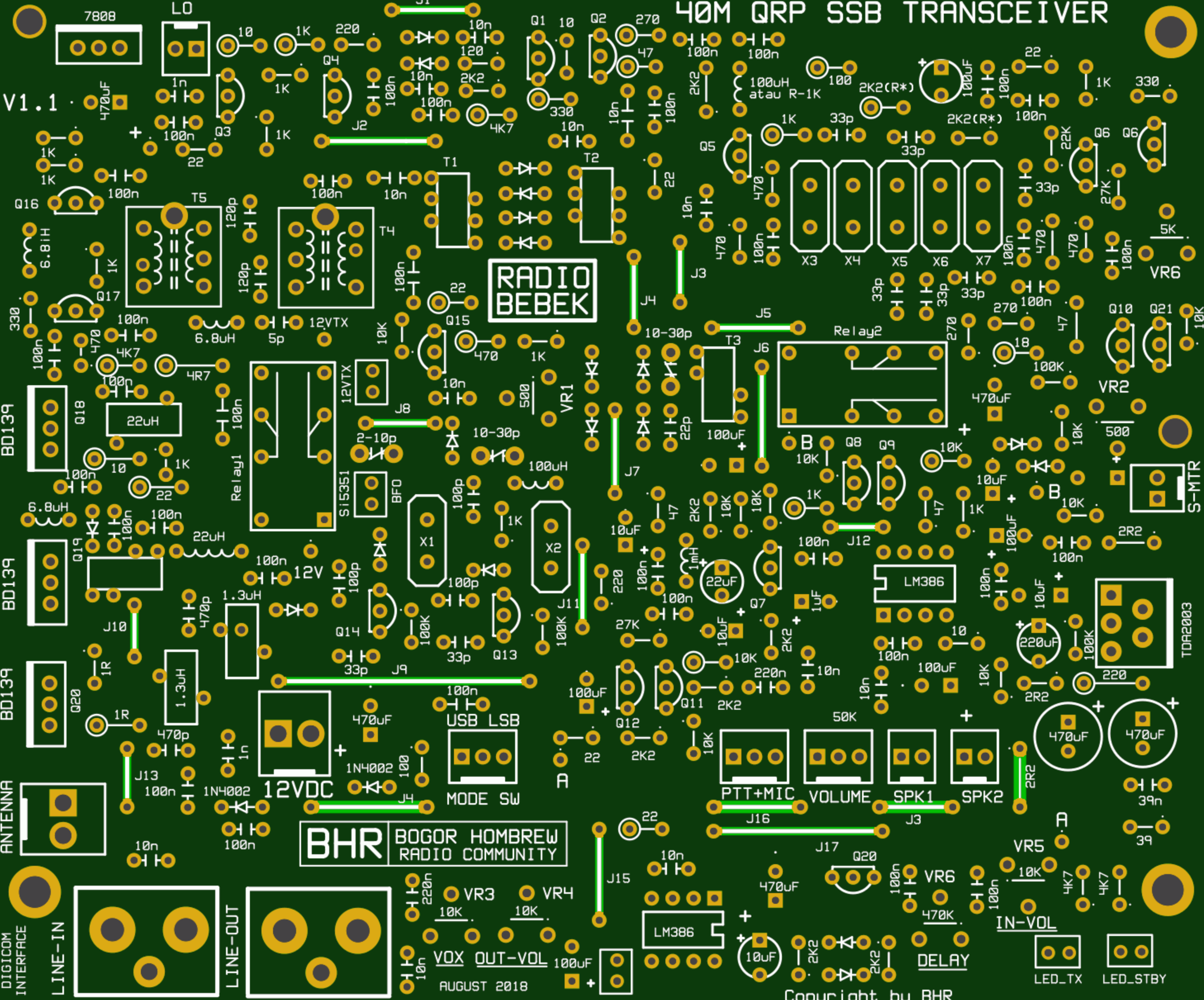

40M QRP SSB TRANSCEIVER

Design by YD1JJJ, YC1COZ, YC1EMK, YC1HBP
YF100, YC2MAP

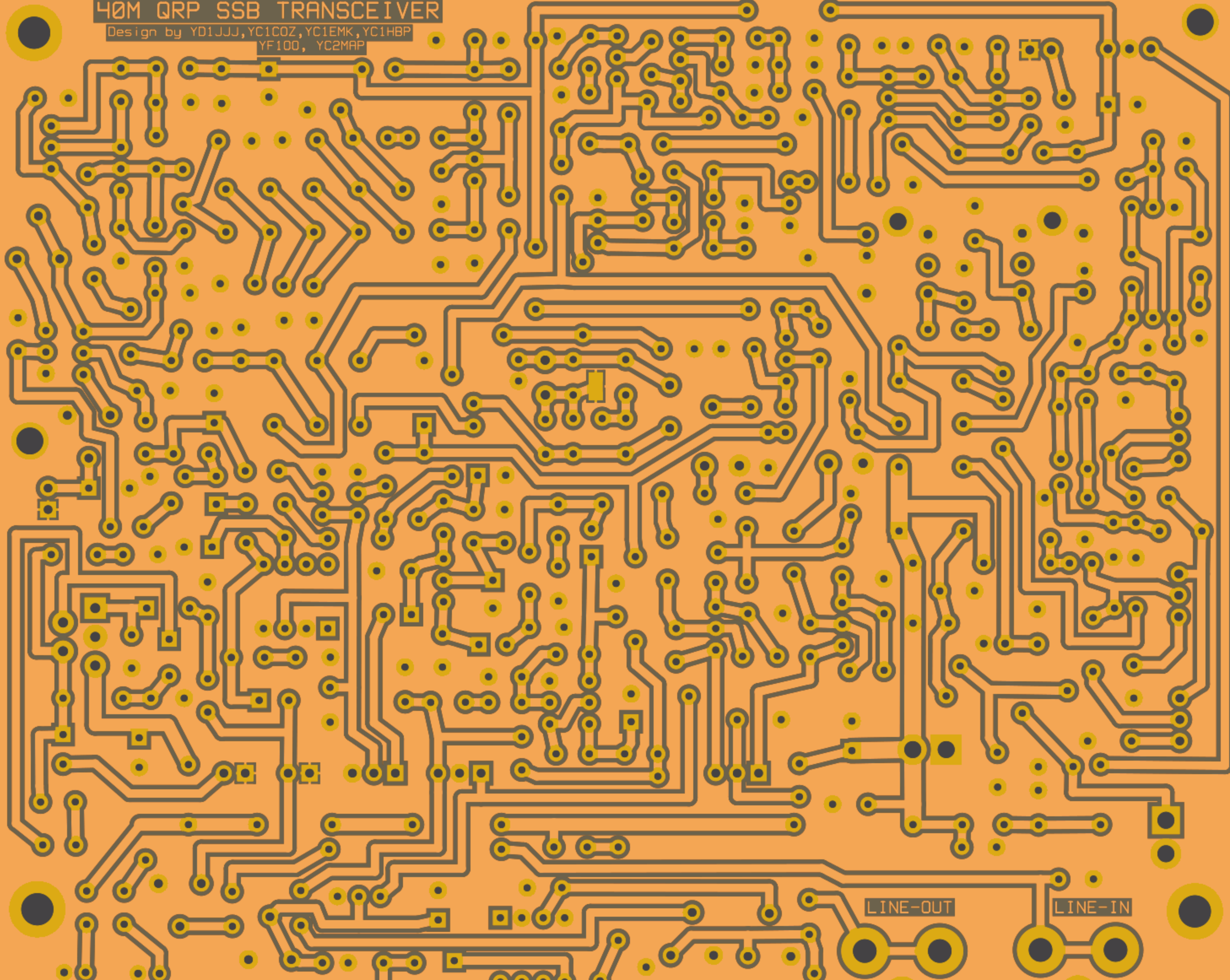

RADIO BEBEK

LINE-OUT

LINE-IN